



Net Tray

-Premium-

***Stainless Steel**

*Stainless steel trays prevent corrosion and discolor after soaking in tray cleaner or disinfectant solution.

Full Arch

A Set : No. 19380
B Set : No. 19383
C Set : No. 19386

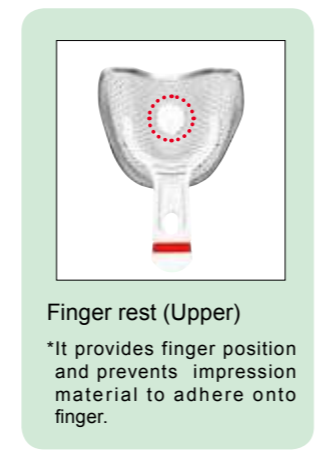
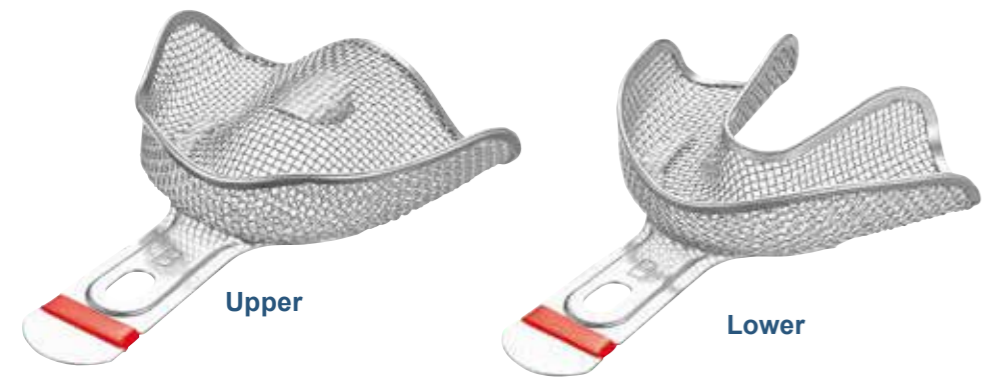

Finger rest (Upper)
*It provides finger position and prevents impression material to adhere onto finger.

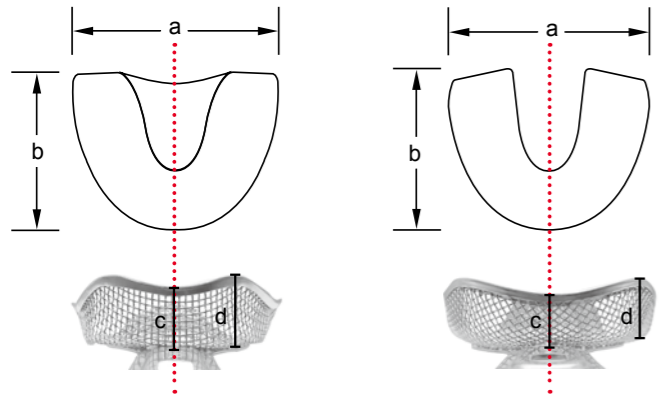

No.	Description	Size (mm)				Color ring
		a	b	c	d	
19381	A for Upper	73	60	19.5	23	Yellow
19382	A for Lower	76	62	15	20	
19384	B for Upper	70	55	17	22	Red
19385	B for Lower	72	58	14.5	20	
19387	C for Upper	66	53	15	20	Blue
19388	C for Lower	69	54	14	18	

*Material / Si (Color ring)

Bi-Lateral

#10 & #11 Set : No. 19390
#12 & #13 Set : No. 19393

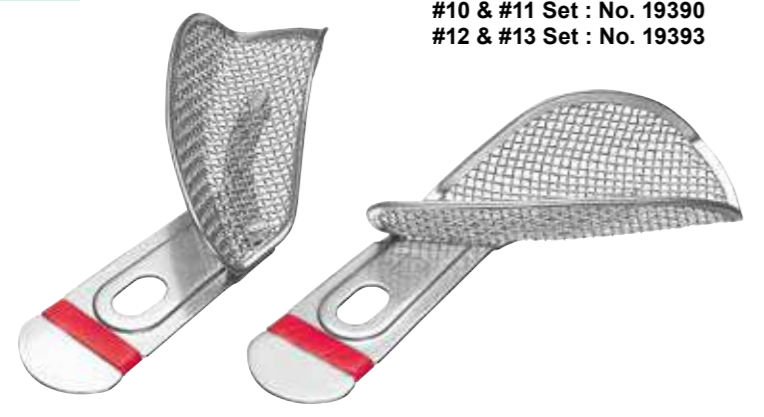

#11 / #13 Upper Right / Lower Left
#10 / #12 Upper Left / Lower Right

No.	Description	Size (mm)		Color ring
		a	b	
19391	#10	20	60	Yellow
19392	#11			
19394	#12	15	58	Red
19395	#13			

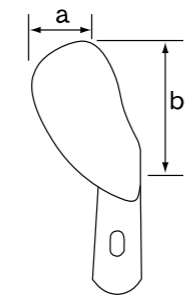

*Material / Si (Color ring)

Local

Local Teeth
No. 19396

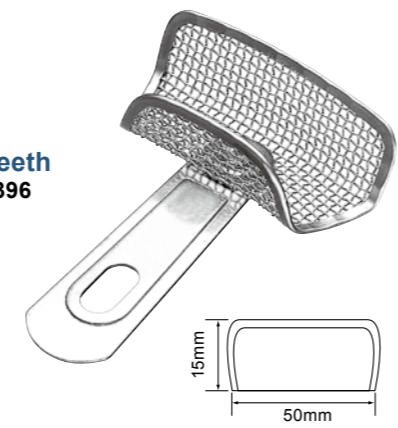

One Tooth
No. 19397

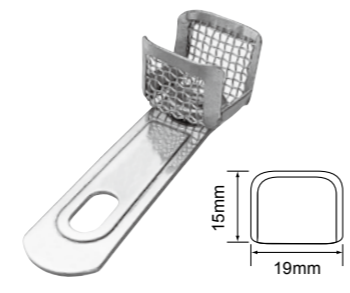

Color Tray

-Premium-

***Aluminium**

*Color coded for easy identification.

*By an edge with height, the impression of a frenum or buccal mucous membrane can be taken firmly.

*Easily bendable for a custom fit.

Upper

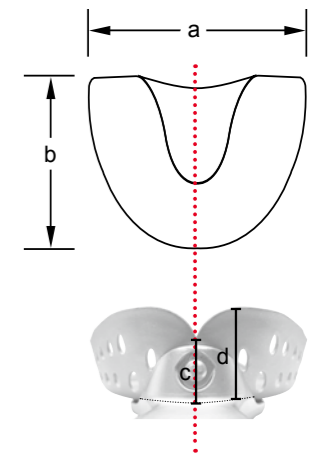

No.	Description	Size (mm)			
		a	b	c	d
19101	Pink	57	48	12	20
19102	Blue	62	54	12	20
19103	Red	68	60	12	22
19104	Gold	75	65	12	22
19105	Violet	84	70	13	22

Lower

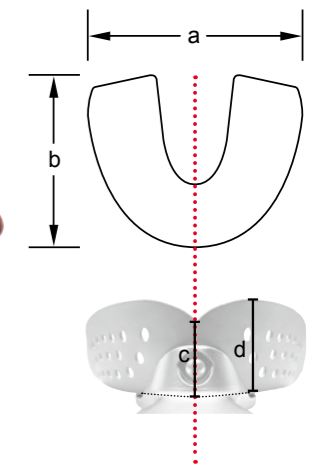
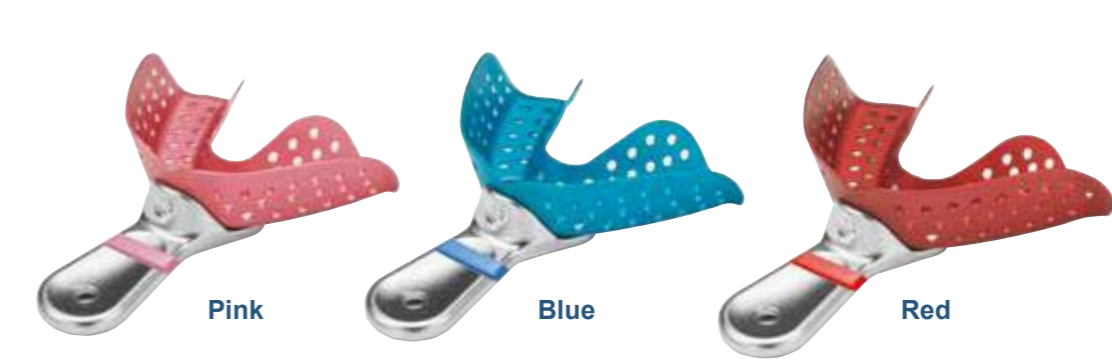

No.	Description	Size (mm)			
		a	b	c	d
19111	Pink	62	44	15	20
19112	Blue	70	48	15	20
19113	Red	75	50	15	20
19114	Gold	82	53	17	22
19115	Violet	88	55	17	22





Impression Tray

-Edentulous Jaw-

***Stainless Steel**

Upper

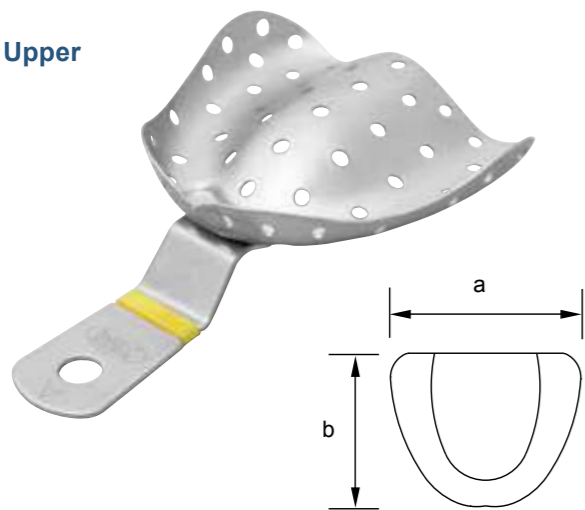

Lower

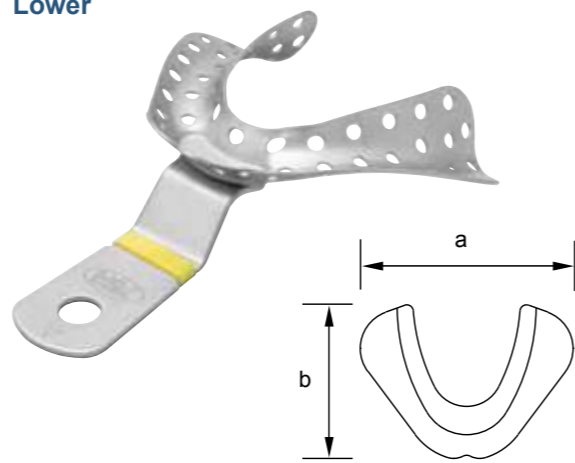

No.	Description	Size (mm)		Color ring
		a	b	
19071	#UA	73	62	
19072	#UB	69	57	
19073	#UC	66	56	
19074	#UD	62	52	

No.	Description	Size (mm)		Color ring
		a	b	
19081	#LA	78	62	
19082	#LB	76.5	59	
19083	#LC	75	54	
19084	#LD	65.5	51	

*Material / Si (Color ring)

-Bi-Lateral-

***Stainless Steel**

**#11
No. 19032**



**#10
No. 19031**

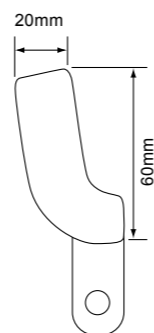
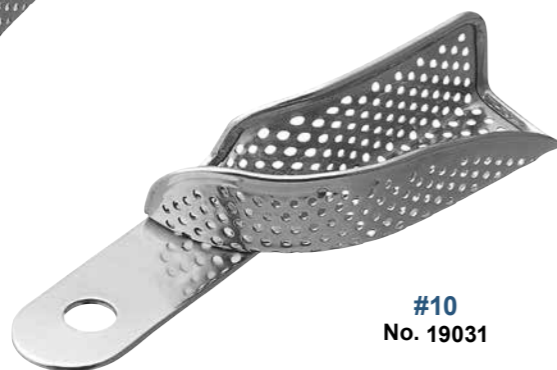

Rotating Tray

***Stainless Steel**

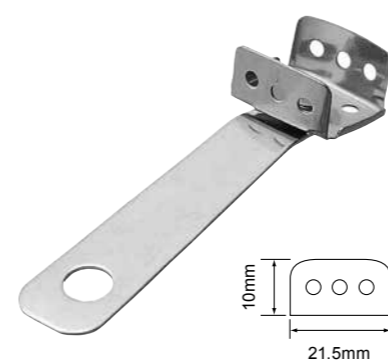

**One Primary Tooth
No. 19461**

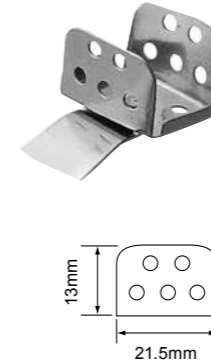

**One Permanent Tooth
No. 19463**

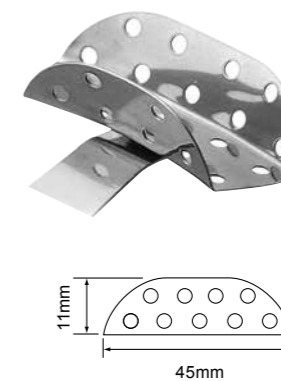

**Local Primary Teeth
No. 19465**

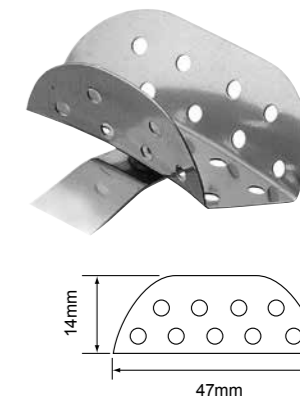

**Local Permanent Teeth
No. 19467**

-Fusayama-

***Stainless Steel**



**S for Posterior
No. 19201**

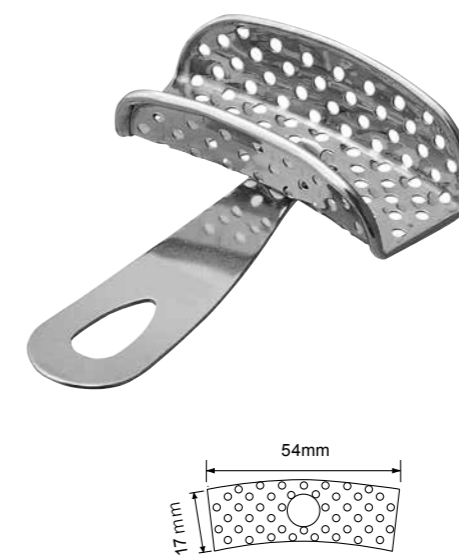

**L for Posterior
No. 19202**

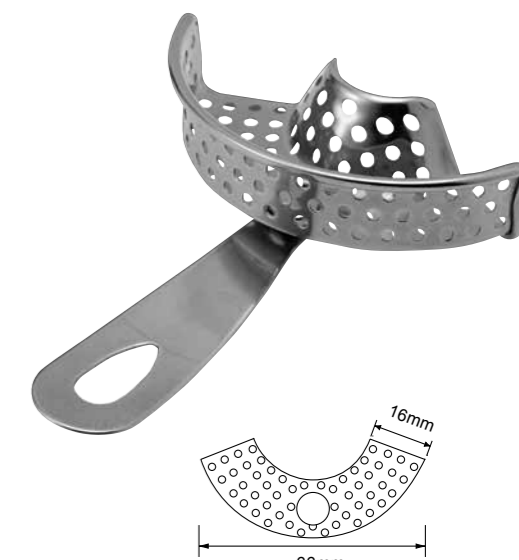

**Anterior
No. 19203**